

EnviroMate GO E20 & VIVA E40

MULTI-PURPOSE STEAM CLEANER SYSTEM
SYSTÈME DE NETTOYAGE A VAPEUR MULTIFONCTION
LIMPIADOR A VAPOR MULTI-USO



INSTRUCTION MANUAL
GUIDE D'UTILISATION
MANUAL DE INSTRUCCIONES

INTRODUCTION.....	2
GENERAL INFORMATION.....	5
• Machine description	5
• Model.....	5
• Technical data	6
• Dimensions and weights	7
• Identification	7
• Symbols shown on the machine and/or on the accessories	8
• List of the parts	8
SAFETY	12
• General safety instructions.....	12
USE.....	13
• Use of the machine.....	13
• Improper use	13
• Unpacking the machine	13
• Steam hose with quick-fit coupling	13
• Using the accessories	15
• Assembling and removing the swivel joint for the brushes	15
• Mounting the cleaning clothes on the brushes..	16
• Mounting the small brushes.....	17
• Filling the boiler (EnviroMate GO)	18
• Filling the tank with water (EnviroMate VIVA)	18
• Connecting to the power source	19
• Turning on and using the machine	20
• Cleaning.....	21
• Cleaning large surfaces	21
• Cleaning pieces of furniture	22
• Cleaning glasses and windows.....	23
• Hints for a better cleaning	25
• Cleaning fabrics/upholstery	25
• Water shortage	26
• Refilling the tank with water	26
• End of use	27

MAINTENANCE.....	28
• Maintenance jobs	28
• Cleaning the boiler	28
• Inactivity of the machine	28
• Troubleshooting.....	29
• Technical assistance.....	30
• Disposal.....	30

No part of this publication may be reproduced, stored in a retrieval system or transmitted in any form or by any means without prior written permission of the manufacturer. Pictures, descriptions, references and technical data in this manual are indicative and not binding. In pursuing a policy of constant quality improvement, the manufacturer reserves the right to effect changes at any time without undertaking to update this manual every time.

IMPORTANT SAFETY INSTRUCTIONS

READ ALL INSTRUCTIONS BEFORE USING THIS APPLIANCE

When using an electrical appliance, basic precautions should always be followed.

WARNING: To reduce the risk of fire, electric shock, or injury:

1. Do not leave appliance when plugged in. Unplug from outlet when not in use and before servicing.
2. Do not use outdoors or on wet surfaces.
3. Do not allow to be used as a toy. Close attention is necessary when used by or near children.
4. Use only as described in this manual. Use only manufacturer's recommended attachments.
5. Do not use with damaged cord or plug. If appliance is not working as it should, has been dropped, damaged, left outdoors, or dropped into water, return it to a service center.
6. Do not pull or carry by cord, use cord as a handle, close a door on cord, or pull cord around sharp edges or corners. Do not run appliance over cord. Keep cord away from heated surfaces.
7. Do not unplug by pulling on cord. To unplug, grasp the plug, not the cord.
8. Do not handle plug or appliance with wet hands.

9. Do not put any object into openings. Do not use with any opening blocked; keep free of dust, lint, hair, and anything that may reduce air flow.
10. Keep hair, loose clothing, fingers, and all parts of body away from openings and moving parts.
11. Turn off all controls before unplugging.
12. Use extra care when cleaning on stairs.
13. Do not use to pick up flammable or combustible liquids, such as gasoline, or use in areas where they may be present.
14. Use only tap water to refill the boiler and water tank. Do not use chemicals, perfumes or other liquid.
15. The hose contains electrical wires. Do not use when damaged, cut, or punctured. Avoid picking up sharp objects.
16. Connect to a properly grounded outlet only. See Grounding Instructions.
17. This appliance is provided with double insulation. Use only identical replacement parts.
18. Do not pick up anything that is burning or smoking, such as cigarettes, matches, or hot ashes.
19. To Reduce the Risk of Fire, do not use a flammable or combustible liquid to clean a floor.

SAVE THESE INSTRUCTIONS

GROUNDING INSTRUCTIONS

This appliance must be grounded. If it should malfunction or breakdown, grounding provides a path of least resistance for electric current to reduce the risk of electric shock. This appliance is equipped with a cord having an equipment-grounding conductor and grounding plug. The plug must be inserted into an appropriate outlet that is properly installed and grounded in accordance with all local codes and ordinances.

WARNING – *Improper connection of the equipment-grounding conductor can result in a risk of electric shock. Check with a qualified electrician or service person if you are in doubt as to whether the outlet is properly grounded. Do not modify the plug provided with the appliance – if it will not fit the outlet, have a proper outlet installed by a qualified electrician.*

This appliance is for use on a circuit having a nominal rating more than 120 volts and is factory-equipped with a specific electric cord and plug to permit connection to a proper electric circuit. Make sure that the appliance is connected to an outlet having the same configuration as the plug. No adaptor should be used with this appliance. If the appliance must be reconnected for use on a different type of electric circuit, the reconnection should be made by qualified service personnel.

CONGRATULATIONS

We would like to thank you, and congratulate you for purchasing the ultimate steam cleaner from Reliable Corporation.

Dry vapor steam cleaning can deep clean and sanitize your home safely and effectively. Vapor steam is effective for killing dust mites, bacteria and mildew. It's ideal for cleaning, sanitizing and deodorizing all the rooms in your house, particularly bathrooms and the kitchen. For family members with chemical sensitivities, vapor steam cleaning is a great way to keep the house clean without using potentially harmful chemicals. Birdcages, aquariums, and pet areas; upholstery, drapery and bedding are all made cleaner and safer for you, your family and your pets when you clean with vapor steam.

For your safety and to fully enjoy the advantages of this product, please take a few minutes to read all the important safeguards and care instructions. Keep this manual handy and review the product warranty card for your reference.

Note: your new steam cleaner may contain small amounts of water as all are factory tested prior to shipping.



IMPORTANT

Carefully read this manual in order to prevent improper use.

The Manufacturer accepts no responsibility for damage to people or things deriving from an improper use of the machine, incompetence, lack of caution or negligence and from the lack of compliance with the instructions provided in this manual.

The pictures shown in this manual are useful to better explain the running, safety instructions and maintenance operations of the machine.

The Manufacturer reserves the right to make changes to its machines, as a result of performance optimization.



ATTENTION

This manual is an integral part of the machine kit. It must be carefully kept within reach and consulted in case of doubt or anytime the need arises. If the machine is given to a third party, even only if it is lent out, please provide the manual along with the machine, specifying to the new user to carefully read its content before operating the machine.



CAUTION

Indicates a potentially hazardous situation exists which, if not avoided, may result in injury.



ATTENTION

Alerts of situations or troubles which can affect the machine efficiency.



IMPORTANT

Draws the attention to important information which does not involve operators safety or the machines efficiency.

The machine has been designed to steam-clean and sanitize household surfaces.

It consists of a boiler fitted with an electrical heater which heats water and produces steam. Using the accessories supplied and the controls and adjustment devices of the machine, steam can be directed towards the surface to be cleaned.

MODEL

The machine is supplied with the basic accessories as specified on page 5.

- EnviroMate VIVA
- EnviroMate GO

TECHNICAL DATA

All components are built with high-quality materials to ensure maximum safety and reliability over time.

		EnviroMate VIVA	EnviroMate GO
BOILER		STAINLESS STEEL BOILER WITH AUTOMATIC FILLING	STAINLESS STEEL BOILER
Max. volume	lt	0,8	2,0
Capacity	lt	--	2,0
Max. steam pressure	kPa	500	500
Cleaning autonomy	h	unlimited	~ 1,45
Ironing autonomy	h	unlimited	~ 3
TANK			
Clean water tank capacity	lt	1,5	--
POWER SUPPLY			
Voltage	V	120	120
Frequency	Hz	60	60
Boiler power	W	1700	1700
CONTROL CIRCUIT VOLTAGE			
Voltage at accessory handle	V	12	12
Voltage at iron	V	12	12
CONTROL DEVICES			
Service pressure switch		x	x
Safety thermostat		x	x
Steam flow regulator		x	
Cap with safety valve			x
Overpressure valve		x	
Control pressure gauge		x	
DEGREE OF PROTECTION:		IP24	IP24

DIMENSIONS AND WEIGHTS

The machine and the accessories it is equipped with are supplied in a practical and sturdy cardboard package that changes from model to model.

Basic composition:	EnviroMate VIVA	EnviroMate GO
Steam generator	x	x
Flexible hose with gun handle	x	x
Extension wands	3 pieces	2 pieces
Swivel joint for brushes	x	x
Rectangular brush	x	x
Cover for rectangular brush	x	x
Triangular brush	x	x
Window squeegee	x	x
Black small brush with bristles \varnothing 60	x	
Red small brush with bristles \varnothing 60	x	
Nylon small brush \varnothing 30	x	
Bronze small brush \varnothing 30	x	x
Steel small brush \varnothing 30	x	x
Curved steam nozzle	x	x
Cleaning cloth	x	x
Filling bottle	x	x
Use and maintenance manual	x	x

Packaging dimensions:		EnviroMate VIVA	EnviroMate GO
		without polystyrene	without polystyrene
Width	mm	400	400
Length	mm	530	530
Height	mm	325	325
Weight:	kg	9,540	9,540

IDENTIFICATION



The data plate of the machine with ETL marking of conformity, is placed at the bottom of the steam generator.



ATTENTION

When asking for information and/or technical assistance, always specify the model and the serial number stamped on the plate.

There may be the following symbols on the machine:

Symbol	Meaning
	This symbol indicates a low level in the clean water tank.
	This symbol indicates that there is no water in the boiler. If the indicator light bearing this symbol comes on, read paragraph "Refilling the tank with water."
	Steam symbol.

LIST OF THE PARTS

IMPORTANT

These instructions show all the available accessories that can be used with the machine. For the basic composition of the model purchased, please refer to the data on the machine package.

IMPORTANT

Standard and/or optional accessories are extra features of the machine and increase the usage possibilities of the same. In any case, the proper functioning of the machine is not related to the quantity of accessories supplied.

Steam cleaner

- 1 Tank plug
- 2 Handle
- 3 Quick-fit coupling seat
- 4 Variable Steam Control
- 5 "Steam pressure" indicator (green light)
- 6 Pressure gauge
- 7 Main switch
- 8 "Water level" indicator (red light)
- 9 Protection flap
- 10 Plug
- 11 Power cord
- 13 Quick-fit coupling
- 14 Safety latch
- 15 Flexible hose with gun handle
- 16 Steam control
- 41 "Water reserve" indicator (red light)

Standard and/or optional accessories

- 20 Joint for brushes
- 21 Rectangular brush
- 22 Red brush with bristles 60mm
- 23 Extension wand
- 25 Squeegee
- 26 Triangular brush
- 27 Grey curved steam nozzle
- 32 Black curved steam nozzle
- 42 Cotton cloth
- 43 Filling bottle
- 46 Nylon brush 30mm
- 47 Bronze brush 30mm
- 48 Steel brush 30mm
- 49 Black small brush with bristles 60mm
- 50 Cover for rectangular brush

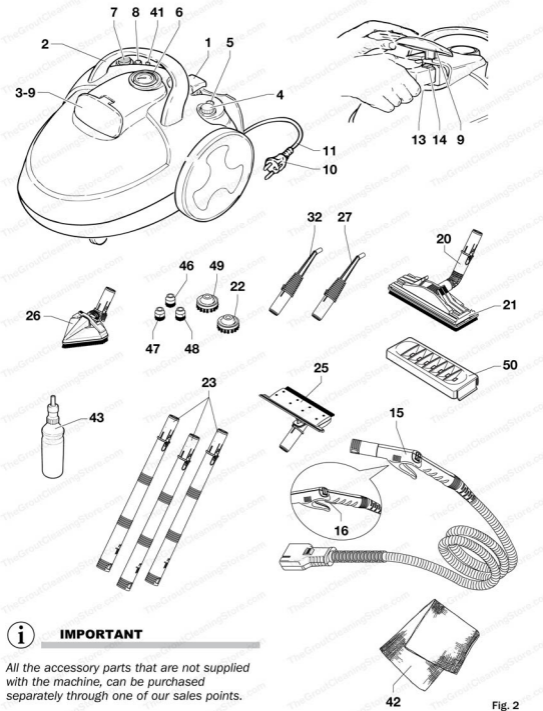

IMPORTANT

All the accessory parts that are not supplied with the machine, can be purchased separately through one of our sales points.

Fig. 2

Steam cleaner

- 1 Boiler cap
- 2 Handle
- 3 Quick-fit coupling seat
- 4 Variable Steam Control
- 5 "Steam pressure" indicator (green light)
- 6 Pressure gauge
- 7 Main switch
- 8 "Water level" indicator (red light)
- 9 Protection flap
- 10 Plug
- 11 Power cord
- 13 Quick-fit coupling
- 14 Safety latch
- 15 Flexible hose with gun handle
- 16 Steam control

Standard and/or optional accessories

- 20 Joint for brushes
- 21 Rectangular brush
- 22 Cover for rectangular brush
- 23 Extension wand
- 25 Squeegee
- 26 Triangular brush
- 32 Curved steam nozzle
- 42 Cotton cloth
- 43 Filling bottle
- 46 Nylon small brush \varnothing 30
- 47 Bronze small brush \varnothing 30

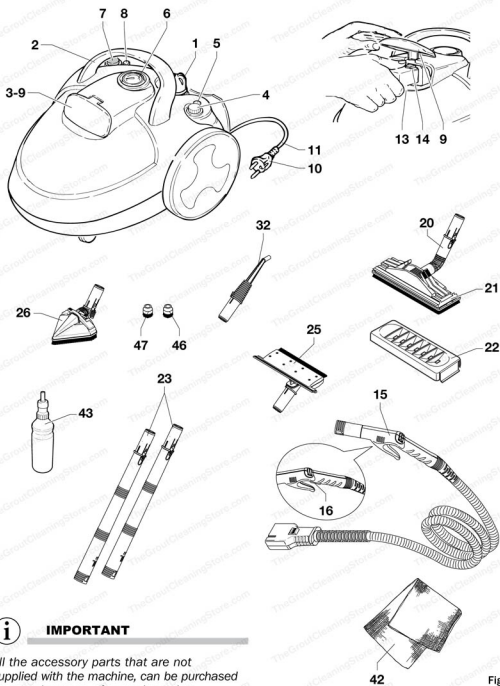

IMPORTANT

All the accessory parts that are not supplied with the machine, can be purchased separately at one of our sales points.

Fig. 2

GENERAL SAFETY INSTRUCTIONS

This chapter provides a list of the general precautions for the safe use of the machine.

- Thoroughly read and understand these instructions before turning on the machine.
- Do not connect the machine to the power source with wet or damp hands or in the vicinity of wet surfaces or jets of water.
- Never plunge the machine into water or other liquids.
- Do not shift or move the machine by pulling its power cord or accessories.
- Do not leave the machine on raised surfaces.
- Before connecting the machine to the power source, make sure the power cord is not defective or damaged.
- During use, make sure the power cord does not come in contact with hot, sharp or abrasive surfaces to avoid damage to its protective sheathing.
- Do not allow children to play with the machine and do not use it for purposes other than those specified in paragraph "Use of the machine".
- If the power cord is not long enough, use approved extensions. If you buy coiled extension cables, always unwind them completely before use.
- Do not cover the machine when it is running.
- Do not reduce the steam passage in the tubes with obstructions or kinks in the hose.
- Do not direct steam at appliances with electrical parts.
- Do not direct steam at persons, animals, plants, hot or cold objects, food and food containers.
- Always unplug the machine from the power source before storing it.
- Do not attempt to open, repair or modify the machine or its components.
- Use the filling bottle provided to fill the boiler.
- Always check that the voltage of the power supply match the voltage of the machine.
- Always make sure that the surfaces being cleaned can withstand the temperature given in paragraph "Technical specifications" without suffering damage. If in doubt, test on a small less visible area.

USE OF THE MACHINE

The machine has been designed and built exclusively to steam-clean/sanitise household surfaces;

The room temperature must be between +5° and +40°.

IMPROPER USE

Any use other than those stated above shall be considered improper.

In particular, it is forbidden to use the machine in areas or places classified as potentially explosive.

ATTENTION

Conformity with the use and maintenance instructions provided by the manufacturer are essential for proper use.

Improper use of the machine voids any warranties, third party liability and the longevity of the machine.

UNPACKING THE MACHINE

Unpack the machine and make sure it is in proper condition.

If you are in doubt about anything, do not use the machine and address concerns to your dealer or the Technical Service Centre.

Keep the package for any return to the manufacturer should maintenance under warranty be necessary.

STEAM HOSE WITH QUICK-FIT COUPLING

Connecting the hose

This operation is necessary to connect the cleaning accessories to the machine.

- 1) Take the quick-fit coupling 13 at the end of the steam hose and check that the safety catch 14 is turned upwards (fig. 3).
- 2) With the other hand lift up flap 9 and push the quick-fit coupling into its seat.
- 3) Ensure the safety catch 14 is locked

ATTENTION

If the catch is not locked, lift up the flap again and push the quick-fit coupling firmly into place.

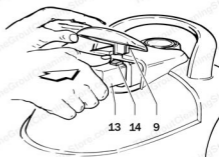

Fig. 3

Disconnecting the hose

- 1) With one hand lift up flap 9 (fig. 4)
- 2) With the other hand seize the quick-fit coupling 13 and with your thumb press on the safety catch 14 and pull outwards to remove it.



CAUTION

Do not carry out this operation if you have wet hands. Also check that the protection flap is placed correctly and is not blocked in the open position.

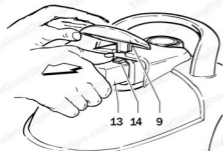

Fig. 4

USING THE ACCESSORIES



ATTENTION

Do not carry out the following operations if the accessories have just been used as they may be hot.

ASSEMBLY

Press the spring button 24 and fit the accessory B you wish to use the handle 15 (or extension wand) as shown in fig. 5. Make sure the spring button 24 is firmly in place A.

DISMANTLING

To remove the accessory, hold the spring button 24 pressed and pull out the accessory.

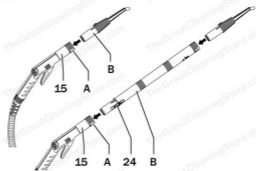

Fig. 5

ASSEMBLING AND REMOVING THE SWIVEL JOINT FOR THE BRUSHES

Fit the square brush (21) and the triangle brush (26) to the handle of the flexible hose or the wands following the steps described in the previous chapter.

The square brush (21) has a small lever C which lets you turn the handle as shown in fig. 6:



- lever in locked position : handle locked;
- lever in unlocked position : handle unlocked and free to rotate right or left.



Fig. 6

MOUNTING THE CLEANING CLOTHS ON THE BRUSHES

The rectangular brush 21 and the triangular brush 26 (if any) are fitted with a holding device for the attachment of a cleaning cloth.

- 1) Lay a cloth on the ground and set the brush right in the middle.
- 2) Press the upper part of the spring-fitted cloth holders D to lift them up. With the other hand, position the front and rear edges of the cloth under the holders. Once released, they will hold the cloth in position (fig. 7-8).

To remove the cloth from the brush, press the holders to lift them up.

To use a cloth on the triangular brush 26, proceed as above using the spring-fitted cloth holders (fig. 9).



Fig. 7



Fig. 8



Fig. 9

MOUNTING THE SMALL BRUSHES

To clean small or hard-to-reach surfaces, we recommend using the small brushes 46-47-48-49, attached to the curved steam nozzle 32.

The two reference marks on the brushes and on the steam nozzle must line up, then press the two components one against the other to couple them (fig. 10).

To remove the brushes, grasp and pull them out.



Fig. 10

FILLING THE BOILER

(for model EnviroMate GO)



ATTENTION

Before filling the boiler, disconnect the machine from the power source.

Before filling the boiler, make sure that:

- 1) plug 10 is unplugged
- 2) the machine is on a flat surface.

Then:

- 1) turn the boiler cap 1 counter-clockwise and unscrew while holding it down.
- 2) pour water into the boiler (from min. 0.5 litres up to the max level indicated using a funnel and being very careful to avoid any water spillage).
- 3) close the cap by rotating it clockwise and, after the first 3-4 turns, hold it down till complete tightening.

FILLING THE TANK WITH WATER

(for model EnviroMate VIVA)



ATTENTION

Before filling the water tank, disconnect the machine from the power source.

Before filling the water tank, make sure that:

- 1) plug 10 is unplugged
- 2) the machine is on a flat surface.



CAUTION

Your steam cleaner has been designed for use with normal tap water. In order to extend the life of this product, if the degree of water hardness is very high in your area, we recommend using 50% tap water with 50% distilled water. Do not use other liquid (chemical, fragrances, etc...).

Then:

- 1) remove the tank plug 1 by turning it counter-clockwise and pour water up to the max level.
- 2) refit and tighten plug 1.

For this operation, we recommend using the filling bottle 43 provided.

CONNECTION TO THE POWER SOURCE

Before connecting the machine to the power source ensure that:

- 1) the voltage and power ratings of the machine stated on the data plate are compatible with the electrical system.
- 2) the electrical system to which the machine will be plugged complies with the local regulations and has a safety switch for a fault current that does not exceed a value of 30 mA.
- 3) the electrical outlet to which the machine must be plugged has a rating of 16 A and is properly grounded
- 4) the power cord has no damage or abrasions and is in perfect condition.



CAUTION

Never connect the plug to the power supply if it is wet or if you have wet or damp hands.



CAUTION

Never pull the electrical cord to unplug unit from the electrical outlet. Instead, take the plug between forefinger and thumb and pull slowly and firmly.



CAUTION

Before putting the plug in the power outlet, make sure the main power switch of the machine is in the "0" position.



CAUTION

If the power cord is damaged, it must be replaced directly by the manufacturer or by qualified personnel an authorized technical service centre.

TURNING ON AND USING THE MACHINE

After the connection to the power source, attach the cleaning accessory of choice.

Press the main switch 7. After a few minutes, the green light 5 comes on to warn that the machine is ready for use.

Pressing the steam control 16 on the handle.

ATTENTION

Do not use the machine in wet or damp places, close to water or to showers, wash-basins, bathtubs, etc.

Do not plunge the machine or its accessories into water.

CAUTION

For model EnviroMate GO:

Open the boiler cap only after eliminating residual steam pressure and disconnecting the machine from the power outlet.

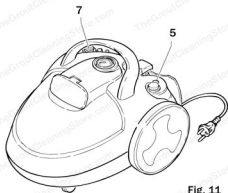

Fig. 11

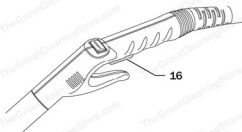

Fig. 12

ATTENTION

These instructions provide basic information on the regulation of the steam flow. These suggestions are given only as an example and intended to offer a general method of familiarization with the machine. When cleaning a surface for the first time test-clean on a small, less visible part of the surface and wait until it dries. This test is required to determine the most suitable steam flow and to ensure that steam will not damage the surface.

IMPORTANT

Before you begin cleaning or when re-starting your work after a pause of 2 minutes or more, release the steam into a container or onto a cloth for about 5 seconds to drain any water off the steam nozzle.

CLEANING LARGE SURFACES

Recommended accessories:

- | | |
|----|-------------------|
| 21 | Rectangular brush |
| 26 | Triangular brush |

ATTENTION

Heat may deform or discolour materials. Obtain information on the appropriate cleaning treatments or, if no information is available, do a patch test on a small less visible part of the surface to be treated. Wait until the surface dries and check for any damage.

If you are unsure about anything, do not proceed.

ATTENTION

The Manufacturer claims no responsibility for any direct or indirect damage to persons or things deriving from misuse or abuse of the machine and from not adhering to principles of basic common sense.

ATTENTION

After use, let the brush bristles cool down before storing to prevent alteration to the bristle structure as they may become malleable from the heat.

Floor cleaning:

Join the wands 23 and attach the rectangular brush 21 fitted with a cloth (fig. 13).

Set the steam regulator to one of the following positions:

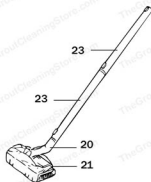

Fig. 13

- Parquet, wood, linoleum (central position)
- Low pile or shag carpeting (central position)
- Marble, fired brick or ceramic floors (maximum position)

ATTENTION

Brush 21 must be always used together with a cloth.

Run the cloth evenly on the surface without pushing down on it. Repeat on heavily soiled areas. In case of ceramic floor, use the brush without cloth to remove persistent dirt. Always wipe the surface with a clean dry cloth to remove the soiled steam residue.

Wax removal from ceramic floors:

Use the brush without cloth; then wipe away the soiled steam residue with a clean dry cloth.

Other large surfaces:

Use the triangular brush 26 or the rectangular brush 21 with or without extension wand.

This set is recommended for:

- Walls tiles
- Blinds, shutters, rolling shutters.

To clean these surfaces, please refer to the instructions above.



IMPORTANT

When cleaning vertical surfaces, always remember that steam dissolves the dirt which runs downward. Therefore, it is necessary to be prepared to collect the dissolved dirt using a clean dry cloth.



IMPORTANT

With extended use or excessive pressure, the brush bristles could pierce the cloth cover and scratch the treated surface. Do not exert undue pressure and regularly check that the bristles are not poking through the cloth. Correct cleaning depends on the steam power rather than on the pressure exerted on the brush.



ATTENTION

When cleaning delicate surfaces or hand-painted tiles, always mount the cloth on the brush. Always carry out a preliminary test by spraying the steam on a small less visible area of the surface and check the results once dry.

CLEANING FURNITURE

Recommended accessories:

26 Triangular brush

Always mount the cloth supplied on the triangular brush 26 and set the variable steam control to an intermediate position (minimum: for ordinary cleaning or delicate surfaces like antique, lacquered or upholstered pieces of furniture; maximum: to remove grease stains from kitchen elements or resistant plastic/laminate furniture).

Run the cloth evenly on the whole surface without pushing down on it. Repeat on heavily soiled areas. If necessary, increase the steam flow. Always, wipe the treated surface with a clean dry cloth after cleaning.

Recommended accessories:

25 Window cleaning tool

Fix the window cleaning tool directly on the gun handle or the wand (depending on the height to be reached), then set the steam knob to the minimum position. Spray the steam over the whole surface by keeping the nozzle at 10 cm. Wipe the glass using the sponge element of the cleaning tool.

 **ATTENTION**

During the colder months, increase the distance to 20 cm to avoid excessive thermal changes between the colder temperature of the glass and the heat of the steam.

After steaming, run the rubber element of the cleaning tool up and down on the whole surface to remove any soiled humidity from the glass (fig. 14).

 **ATTENTION**

An up and down motion is fundamental to correct cleaning. It is also important to periodically wipe off the dirt collected by the rubber part with a clean cloth.

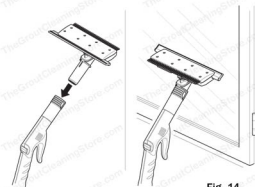

Fig. 14

RECOMMENDED ACCESSORIES

- 32 Curved steam nozzle
- 46 Nylon small brush 30mm
- 47 Bronze small brush 30mm
- 48 Steel small brush 30mm
- 49 Brush with bristles 60mm

These accessories let you treat difficult/hard to reach surfaces. They allow the cleaning of:

Grout between tiles or floor-tiles, skirting-boards and areas close to furniture and radiators. For these surface, use either the curved steam nozzle 32 fitted with the small brushes 46 (fig. 15-16).

Door jambs, frames, blinds, shutters, Venetian blinds. For these surfaces, in addition to the accessories above, the large brush 49 (\varnothing 60) (fig. 17) is recommended.

Non scratching surfaces (car engines and components, cast iron cooker rings, etc.). For these surfaces, in addition to the accessories above, the crevice nozzles 47 and 48 with metal bristles are recommended.

Choose the accessory which best suits the cleaning to be carried out, fit it to the curved gun and, depending on the height to be reached, add one or both wands.

Set the steam knob to a low-medium position according to the degree to which the surface is soiled and the delicacy of the surface (low=dirty or delicate surface; medium=very dirty or resistant surface).

Spray the steam on the surface and, using the steam pressure, collect the dissolved dirt in a single point, then wipe with a clean dry cloth.

Keep the nozzle 5-10 cm away from the surface to be treated.

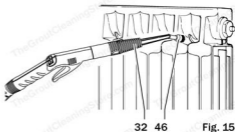

Fig. 15



Fig. 16



Fig. 17



CAUTION

During use do not touch the accessories. Before replacing them, wait some 5 minutes to let them cool down. Always keep at a safety distance of 80 cm from steam.

As steam dissolved dirt tends to run downward, start cleaning from the top and use steam to direct the dirt to a lower point, then wipe with a clean dry cloth.

When treating points which, due to their inaccessibility, have been seldom cleaned, you must be prepared to collect a lot of dirt. For this reason, it is advisable to first use a cloth to remove most of the dirt, then a second clean cloth to wipe off any residual dirt resulting from the steaming process.

Some drops of dirt could soil the floor. To optimize the sanitizing process, we recommend cleaning the floor last. Using the jet of steam, collect the dirt in a single point, then wipe off with a clean dry cloth.

ATTENTION

Due to their nature, scale deposits cannot be dissolved by steam. Therefore the machine is not suitable for the removal of calcium deposits.

After every pause of 2 minutes or more, remember to direct the first jet of steam towards a cloth or a bucket.

The bristles of the small brush significantly increase the cleaning effect of the nozzles, but may also scratch the treated surface. Use caution when cleaning with this accessory.

Recommended accessories:

26 Triangular brush

ATTENTION

Especially for this kind of cleaning, it is essential to test on a small less visible part of the surface to be treated and to check -after drying- that the surface has not been damaged.

The machine can be used for cleaning carpets and sofa or armchair upholstery. To do this job, always use the triangular brush 26 with a cloth and turn the steam knob to the low-medium position. Check often while cleaning that the brush bristles do not pierce the cotton cloth and scratch the fabric. To remove stains, cover the whole surface, but especially the stain, many times with the triangular brush fitted with cloth, paying attention not to press down too much; use steam at regular intervals of about 5 seconds; between two jets of steam, continue wiping the fabric with the brush and the cloth. Let dry and check if the stain has disappeared. If the result is not satisfactory, repeat the process.

CAUTION

Never clean electric household appliances.

CAUTION

Do not clean the machine or its components using the steam jet or plunging the same into water. When finished using disconnect it from the power source and clean the surface with a soft damp cloth.

CAUTION

Do not direct the steam at people or animals.

For models EnviroMate GO:

The red indicator light 8 comes on to warn there is no more water in the tank.

ATTENTION

Do not leave the boiler without water for a long time: this could result in damage to the machine.

For model EnviroMate VIVA:

When the red indicator light 8 (the symbol ) comes on and an intermittent beep sounds, the tank is running out of water and steam flow will be interrupted.

Two options:

- stop your cleaning and store the machine (see paragraph "End of use")
- or refill the boiler (see paragraph "Refilling the tank with water").



CAUTION

First unscrew the boiler cap with two-three turns very slowly (while holding it pressed down) to eliminate any residual pressure, then remove the cap.

For models EnviroMate GO:

Disconnect the machine from the power source and proceed as follows:

- 1) Wait at least 10 minutes so the pressure in the boiler can drop, then loosen the boiler cap 1 two-three turns very slowly while holding the cap pressed down to eliminate any residual pressure.
- 2) Unscrew and remove the boiler cap.
- 3) Pour water into the boiler (from min. 0.5 litres up to the max recommended level indicated on page 4 "Technical data") using a funnel and being very careful to avoid any water spillage.
- 4) Close the cap by rotating it clockwise and hold it pressed down to screw it completely.

ATTENTION

Low water level is also signalled by a reduction of the steam jet.

For model EnviroMate VIVA:

Disconnect the machine from the power source and proceed as follows:

- 1) Remove the tank plug 1 by turning counter-clockwise and pour water up to the max level.
For this operation, we recommend using the filling bottle 43 provided.
- 2) Refit and tighten plug 1 and restart your work.

ATTENTION

The water shortage is also signalled by a reduction of the steam jet force.

END OF USE

Once you have finished your cleaning and before storing the machine, turn off the main switch 7, disconnect the plug from the socket and roll up the power cord 10 onto the cord storage brackets.

The machine is built with extremely reliable technology and components; therefore it does not require any special maintenance.

Careful use and strict compliance with these instructions are the best way to achieve the best possible results and high-level performance.

CLEANING THE BOILER

We recommend eliminating any scale deposits from the boiler at least twice a year as follows:

- Disconnect the machine from the power source.
- Place a container under the machine, then remove plug X by turning it counter-clockwise using round nose pliers or the spanner provided (fig. 18).
- Drain the boiler into the container, then refit plug X with the relevant washer R.

CAUTION

This job must be performed after the machine has cooled down completely.



Fig. 18



ATTENTION

Disconnect the machine from the power source before doing the following operations.

Once finished using the machine, do the following:

- store the machine in a dry place which is not subject to sudden temperature changes.
- in case of long inactivity, empty the water tank or the boiler to prevent scale sediments from building up. To do this job, unscrew the closing cap 1, turn the machine upside down and drain the water into a suitable container (bucket, basin, etc.).
- clean the machine with a soft cloth and some water; do not use any solvents or detergent.
- store the machine on a horizontal surface (on the floor, if possible).

PROBLEM	SOLUTION
<ul style="list-style-type: none"> When switch 7 is turned on, the indicator light 8 comes on (model EnviroMate GO). 	<ul style="list-style-type: none"> Ensure you have enough water in the boiler. Add water, if necessary. If the defect persists, address concerns to your Dealer or authorized Technical Service Centre.
<ul style="list-style-type: none"> The red light 8 (symbol ) comes on (only model EnviroMate VIVA). 	<ul style="list-style-type: none"> Consult paragraph "Refilling the tank with water."
<ul style="list-style-type: none"> Extension wands or accessories are hard to fit. 	<ul style="list-style-type: none"> Lubricate the gaskets with some oil.

In the event of failures or breakdowns of the machine or any part of the same, the Manufacturer recommends contacting the dealer or the nearest Technical Service Centre where items will be repaired using original spare parts.



IMPORTANT

The use of non-genuine spare parts by technicians not authorised by the Manufacturer or any attempt of repair carried out by non-authorised individuals will immediately make the warranty void and/or release the Manufacturer of any liability for possible damage to people, animals or things.



Any product or packing bearing the symbol above cannot be regarded as a normal household waste and should be separated and delivered to an agreed collection and recycling centre for waste electrical and electronic appliances.

By disposing of this product in the recommended way, you will avoid potential negative consequences that could result from an improper disposal of the product.

For more information on the recycling of this product, consult your municipal office, the local waste disposal centre or the location where you purchased the product.



ATTENTION

Immediately after you decide to dispose of the machine, remove the power cord.



RELIABLE

1 800 268 1649

www.reliablecorporation.com